

Recess 4.5" for Sloped Ceilings Color Select Tunable White Downlight

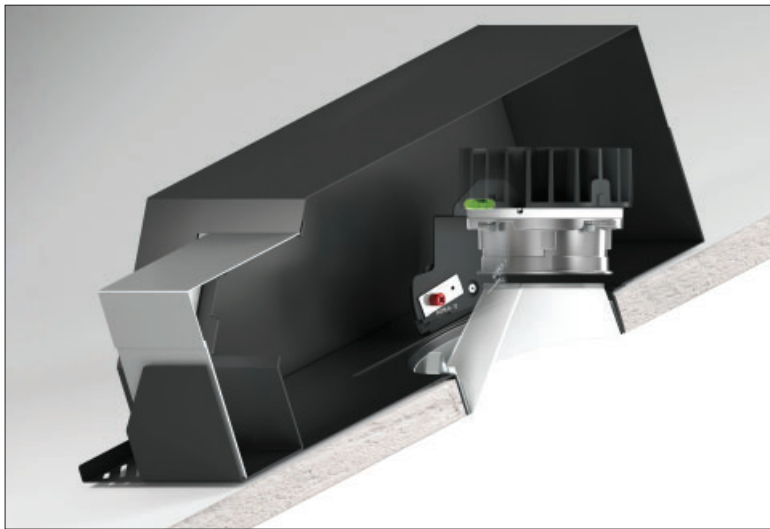

Recess 4.5 inch for Sloped Ceilings Color Select Tunable White Downlight

An elegant solution for beautiful recessed lighting, with a smooth transition from cool white light to warm, for sloped ceiling installations up to 45 degrees. Featuring solutions for angles from 15° (3/12 pitch) to 45° (12/12) pitch to create a perfectly round or square roomside appearance to make every space look its best.

- **Ideal Applications:** Medium to Large-Scaled Spaces
- **Recommended for Ceiling Height:** 14' – 20'
- **Light Type:** Tunable White light from warm candlelight (2200K) to bright daylight (6000K)

4.5" DOWNLIGHT PERFORMANCE DATA

Shape	Color Select Tunable White	
	Round	Square
Delivered Lumens:	800 / 1325	850 / 1400
Lumens Per Watt:	50 / 41	53 / 44
Source Lumens:	1250 / 2075	
Wattage	16W / 32W	
CCT:	2200K - 6000K	
CRI:	80+	
Beamspread:	40°	
	Medium Beam / Straight Down	

Round Trims



Square Trims



Universal and Field Convertible - Trim | Trimless | Millwork

4' SPACING BETWEEN LIGHT FIXTURES

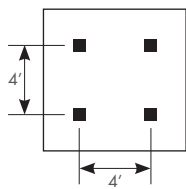

4' x 4' LAYOUT	CEILING HEIGHT
Light levels at:	8' 10' 12' 14' 16' 18' 20'
Light levels on Work Plane (2.5' AFF):	71 63 57 51 46 41 37 (fc) foot candles

5' SPACING BETWEEN LIGHT FIXTURES

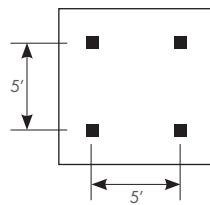

5' x 5' LAYOUT	CEILING HEIGHT
Light levels at:	8' 10' 12' 14' 16' 18' 20'
Light levels on Work Plane (2.5' AFF):	58 52 45 44 41 37 34 (fc) foot candles

6' SPACING BETWEEN LIGHT FIXTURES

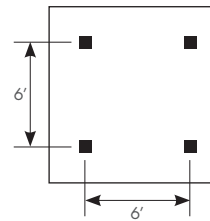

6' x 6' LAYOUT	CEILING HEIGHT
Light levels at:	8' 10' 12' 14' 16' 18' 20'
Light levels on Work Plane (2.5' AFF):	42 41 39 37 35 32 30 (fc) foot candles

8' SPACING BETWEEN LIGHT FIXTURES

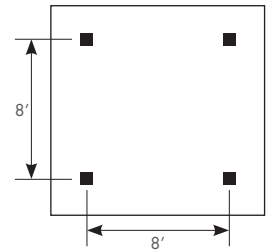

8' x 8' LAYOUT	CEILING HEIGHT
Light levels at:	8' 10' 12' 14' 16' 18' 20'
Light levels on Work Plane (2.5' AFF):	28 25 22 20 18 16 15 (fc) foot candles

Light Levels based on 32W Fixture Model. Multiplier for approximate foot candles at 16W: 0.6
 Spacing Criteria: Round: (0-180) 0.5, (90-270) 0.7 / Square: (0-180) 0.58, (90-270) 0.84
 30°-45° Sloped Ceiling: Round: (0-180): 0.58, (90-270) 0.66 / Square: (0-180) .64, (90-270) 0.86

Average light levels are provided in the tables above, for a range of lighting fixture layouts and ceiling heights. All illuminance values are reported in average footcandles (fc) and measured at the workplane, 30" above the floor.

For approximate light level recommendations, please refer to the IES guidelines shown below:

- | | | |
|---|---------------------------|--|
| Workshop / Tools / Crafts: 40-100 fc | Kitchen: 30-50 fc | Reading: 20-50 fc |
| Board Games / Cards: 20-40 fc | Computer: 15-30 fc | Dressing: 10-30 fc |
| Dining: 5-10 fc | Media: 2-20 fc | Corridors / Circulation: 3-5 fc |

Recess 4.5" for Sloped Ceilings

Color Select Tunable White Downlight



Seven Easy Steps to Specify

1 Select Ceiling Slope

For 15° (3/12) - 30° (7/12) Sloped Ceilings

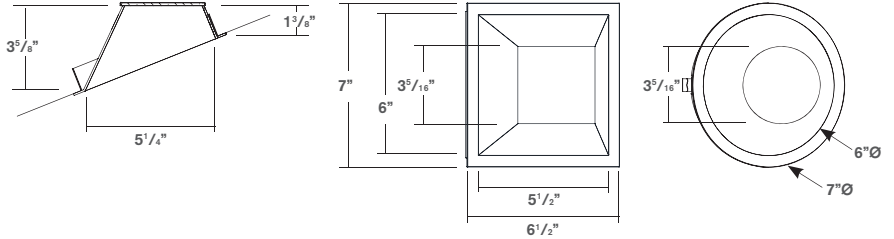

For 30° (7/12) - 45° (12/12) Sloped Ceilings

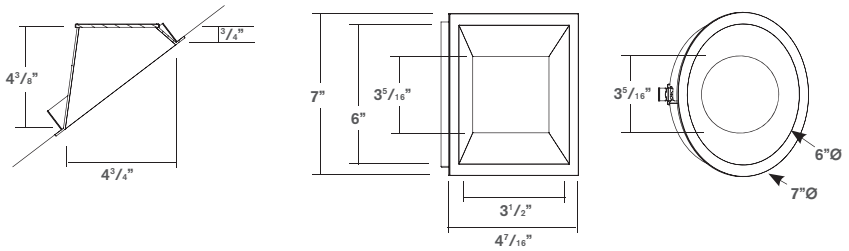

2 Select Housing Type

For Ceilings without Insulation

32W New Construction Sloped Housing - (NS)

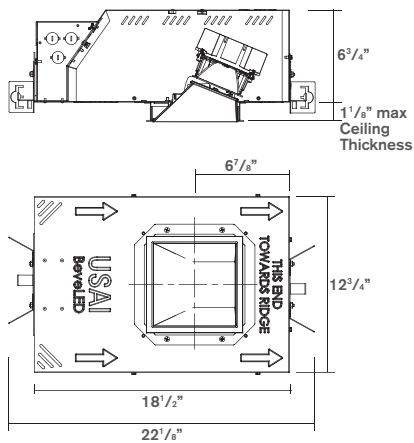

For Insulated Ceilings

16W New Construction / IC Rated Housing - (IS)
Rated for Direct Contact with Insulation

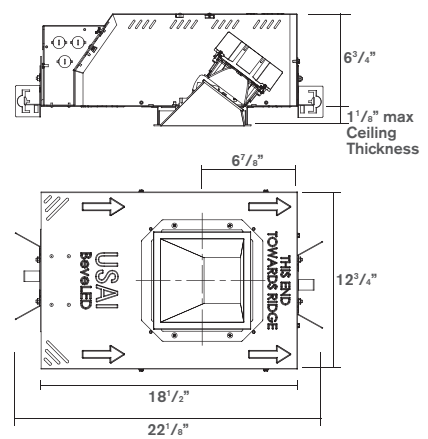

Recess 4.5" for Sloped Ceilings Color Select Tunable White Downlight

3 Select Wattage per Housing Type

32W NS Housing
0-10V Low Voltage Dimming

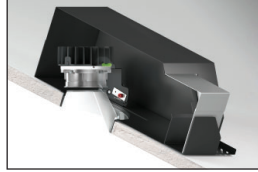

Compatible with 0-10V Controls

16W IS Housing
0-10V Low Voltage Dimming

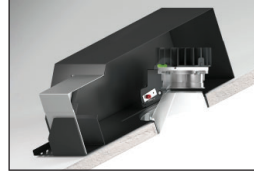

Compatible with 0-10V Controls

4 Select Shape

Square



Round



5 Select Trim Style For Ceiling Type

Trimmed (F)
for All Ceiling
Types



Trimless (P)
for Sheetrock Ceilings Only
(Must be Spackled In)



Millwork (M)
for Millwork and
Stone Ceilings

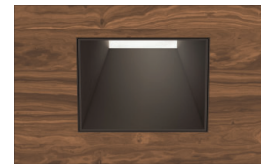

6 Select Glass Lens

Solite (S)
provided standard)
Light diffusion
with the most
efficiency

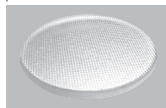

Frosted (F)
Medium diffusion
for softer light
output, approximately
12% less light output



7 Select Trim Finish

White (WH)
provided standard



Black (BL)



**Statuary
Bronze (BZ)**

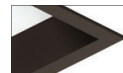

**Metalized
Grey (GR)**



Primer (PR)



See Next Page For
How to Specify

Recess 4.5" for Sloped Ceilings Color Select Tunable White Downlight



How to Specify

Manufacturer	Light Fixture Type			LED + Control			Options				Revision
USAI	4DL			TW1				G			00
USAI	Family	Function	Housing Type	LED Color	Wattage Driver	Shape	Style	Beam Spread	Lens	Finish	Version
USAI Lighting	4DL 4.5" Downlight, 16W or 32W	S3 For 15°-30° Sloped Ceilings S5 For 30°-45° Sloped Ceilings	NS New Construction Sloped	TW1 Color Select Tunable White from 2200K to 6000K, continuously variable through 0-10V controls by Savant	IV32A Integral 0-10V Dimming Driver, to 1% 120V-277V, 32W	R Round S Square	F Trimmed P Trimless M Millwork	G 40° Beam	S Solite Textured Glass (provided standard) F Frosted Glass	WH White (provided standard) BL Black BZ Statuary Bronze GR Metalized Grey PR Primer	00
			IS Insulation Contact Sloped	TW1 Color Select Tunable White from 2200K to 6000K, continuously variable through 0-10V controls by Savant	IV16A Integral 0-10V Dimming Driver, to 1% 120V-277V, 16W	R Round S Square	F Trimmed P Trimless M Millwork			WH White (provided standard) BL Black BZ Statuary Bronze GR Metalized Grey PR Primer	

Recess 4.5" for Sloped Ceilings Color Select Tunable White Downlight

RECESS 4.5 SLOPED SPECIFICATIONS

FIELD REPLACEABLE LED LIGHT ENGINE

is serviceable through the aperture without tools. All USAI Lighting Color Select Tunable White light engines feature industry leading color consistency.

FIELD REPLACEABLE DRIVER

Driver complies with IEEE62.41 surge protection. Provided with integral 0-10V 1% dimming driver; some on-time delay may be experienced, depending on control system used.

ADJUSTMENT:

Sloped ceiling housings are fitted with an integral bubble leveling device to ensure perfectly level installations and optical alignment. Optical assembly can be tilted and locked in position for ceiling slopes from 3/12 pitch to 12/12 pitch, which are visually indicated on tilt mechanism. Butterfly brackets are imprinted with ceiling thickness indexing allow installers to easily preset housing prior to installation: choose from ceiling thicknesses of 1/2", 5/8", 3/4", 7/8", 1", or 1-1/8".

HOUSING:

Fabricated of 20 ga. galvanized steel with thru wire J-box, 4 in 4 out at min. 90°C, #12 AWG thru branch circuit wiring. IC-rated housings for use with 16W light engines only are rated for direct contact with insulation of R-42 or less.

MOUNTING:

Butterfly brackets and adjustable nailer bars with integral nails provided. Nailer bars are extendible from 16" to 24" centers.

CEILING CUT OUT:

Round Trimmed: 6-5/8" Ø

Round Trimless: 7-1/8" Ø

Round Millwork: 6-7/16" Ø

Square Trimmed: 6-5/8" x 6-5/8"

Square Trimless: 7-1/8" x 7-1/8"

Square Millwork: 6-7/16" x 6-7/16"

LISTINGS:

Dry/Damp/Wet location rated. NRTL/CSA-US tested to UL standards. IBEW union made.



NOTES:

- Not for use in corrosive environment.
- Use of pressure washer voids warranty.

PHOTOMETRICS:

Consult factory or website for IES files. Tested in accordance with IESNA LM79.