

SAVANT



Current Track Module (Supports QO Style Load Centers)

Quick Reference and Installation Guide

Box Contents

- (1) Current Track Module
 - GPM-Q2SEM-xx w/Pigtail type neutral
- (1) 4-pin screw down plug-in connector (028-9395)
- (1) Product Information and Regulatory Insert (009-1950)
- (1) Quick Reference and Installation Guide (this document)

Specifications

Environmental	
Temperature	-22° to +122° F (-30° to +50° C)
Humidity	Up to 90% Relative Humidity (non-condensing)
Location	Indoor use unless installed in a NEMA 3R rated enclosure
Dimensions and Weights	
	Length Width Height Weight
Module (QO)	4.97 in. (12.63 cm) 1.45 in. (3.68 cm) 2.60 in. (6.61 cm) .5 lbs (.23 kg)
Shipping	7.50 in. (19.05 cm) 4.30 in. (10.92 cm) 1.71 in. (4.34 cm) 1.0 lbs. (.45 kg)
Power	
Input Power (powers the module)	120V AC (+/- 10%) @ 60 Hz, 0.1A (max)
Signal Input	0.333V AC @ 60Hz
Type of Action	Type 1 action
Standards	
Wireless	Bluetooth 5 Low Energy (BLE) - 2.4 GHz radio frequency
This module will be tested and certified to the following standards:	
ANSI C12.20-2015	American National Standard for Electricity Meters - 0.5 Accuracy Class
ANSI C12.1-2014	American National Standard for Electric Meters - Code of Electricity Metering
Regulatory	
Safety and Emissions	FCC Part 15 UL ICES 003
	 
Contains FCC ID: PUU-HQC2SEM	Contains IC: 10798A-HQC2SEM
RoHS	Compliant
Recommended Load Center Types	
See the Features section to the right for compatibility information	
Electrical and Safety Characteristics	
Pollution Degree	2
Purpose of Control	Energy Monitoring
Software	Class A
Impulse Voltage	2500V
Construction of Control	
Open Type	Independently mounted for flush mounting
Minimum Supported Release	
Savant OS	da Vinci 10.2.3

Descriptions

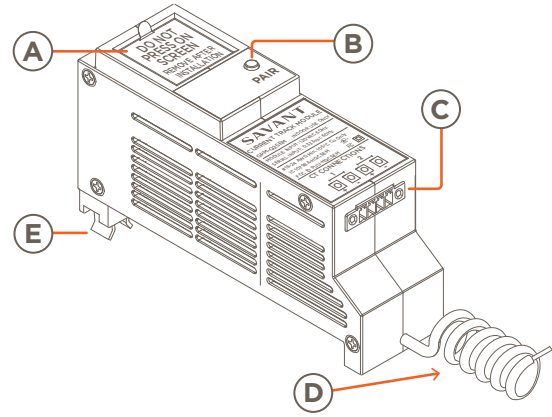

LCD screen that displays the following according to user input

- Real-time energy usage
- Firmware and mac address
- UID of the connected Host
- Real-time Bluetooth status connectivity icons
- Step-by-step hardware setup process

A

PAIR Button - The duration the PAIR button is pressed determines its function:

B

Press and Release - Cycle through the screens available on the LCD (POWER > ENERGY > INFO 1 > INFO 2)

Press and hold (3 seconds) - Bluetooth Discovery mode

Press and hold (5 seconds) - See [Reset Module](#)

C

CT Connections - Input ports 1 & 2 for CT Wiring. Refer to the [CT Wiring](#) section for wiring information

Pigtail Neutral - The neutral wire protrudes from the rear of the module and is wired to the neutral bar

D

TIP! Modules with an external neutral wire (pigtail) are supported in plug-on neutral type electrical panels. In these cases, the pigtail wire must be connected directly to the neutral bus bar.

E

120V AC Connection - The Current Track Module is plugged into and powered from the 120V AC bus bar in the electrical service panel

Features

- The GPM-Q2SEM is compatible with Schneider/Electric Square D™ QO™ load centers
- Energy monitoring; +/- 0.5% revenue grade accuracy / 1 sec sample time when used with revenue grade current transformers
- Communication with a Panel Bridge Controller, Director, or Director Lite is achieved over Bluetooth Low Energy (BLE)
- Color LCD display for easy identification

Accessories

Current Transformers	
SEM-050Ax	50 Amp
SEM-150Ax	150 Amp
SEM-250Ax, SEM-REV250Ax	250 Amp
SEM-400Ax, SEM-REV400Ax	400 Amp
SEM-600Ax, SEM-REV600Ax	600 Amp
SEMFLEX-2500Ax,	2500 Amp

ELECTRIC SHOCK! The 120V AC, 60 Hz source poses an electrical shock hazard that has the potential to cause serious injury to installers and end users

CAUTION! Risk of Electric Shock - More than one disconnect switch may be required to de-energize the device before servicing. Always disconnect the power to the module before making any connections. ring Modules

IMPORTANT! A licensed electrician is required to install any Savant Power and Energy Modules

CHOC ÉLECTRIQUE! La source alimentation électrique de 120 V AC, 60 Hz présente un risque d'électrocution susceptible de causer des blessures graves aux installateurs et aux utilisateurs finaux

ATTENTION! Risque de choc électrique - Plus d'un interrupteur de déconnexion peut être nécessaire pour mettre l'appareil hors tension avant l'entretien. Débranchez toujours l'alimentation du module avant d'effectuer des connexions

IMPORTANT! Un électricien agréé est requis pour installer l'un des modules de surveillance de l'alimentation et de l'énergie de Savant

Important Information

- All Current Track Modules require two spaces in an electrical service panel
- All wiring in the United States must be installed in accordance with the latest adopted edition of the National Electrical Code (ANSI/NFPA 70, NEC)
- All wiring in Canada must be installed in accordance with the latest adopted edition of the Canadian Electrical Code (CSA C222.2 CEC, Part 1) and any provincial or local requirements
- Use only Savant approved current transformers. A list of supported transformers is available in the [Accessories](#) section
- The largest current transformer offered from Savant supports wire diameters up to 14.5 inches

Install Module

IMPORTANT! See the [CT Circuit Monitoring](#) section before plugging the module into an electrical panel

1. Remove power from the electrical service panel by switching off the panel's main breaker
2. Position and install the Current Track Module into the appropriate spaces
3. Press firmly until fully seated onto the bus bars

Install Current Transformer

Up to two current transformers can be connected to a GPM-Q2SEM. To connect the CTs into an electrical panel, follow the steps below:

1. Toggle the the main breaker and electrical panel's main breaker OFF
2. Remove the panel's front cover and set it aside. Verify that power is removed from the circuit breakers using a voltage tester
3. Separate the current transformer by squeezing the knurled panel and pulling/rotating the top open
4. Place the current transformers around each of the conductors being monitored

IMPORTANT NOTES!:

- 20 and 50A CTs must be oriented so the arrow in the middle points towards the load
 - CTs 150A or higher must be oriented with the label facing towards the power source
5. Close the current transformer around the conductor. For added security, wrap a cable tie around the CT or run the tie through the loops on the front.
 6. Route the twisted black and white wires from the current transformer panel back to the module so they don't directly come in contact with a live bus bar or terminal
 7. Observing polarity, insert the wires into the supplied 4-pin connector and secure by turning screws clockwise. Review the [CT Wiring](#) section to the right for information
 8. Repeat steps 3-7 to install additional current transformers if needed
 9. Ensure the 4-pin connector is fully seated into the module and tighten the connector's screws to 0.18 ft-lb (.25 N-m) max
 10. Toggle the main breaker back to the ON position and re-apply power to the electrical panel.

IMPORTANT NOTES!:

- If the module displays negative readings then check for the CT connected to the wrong phase, CT reversed on the correct phase, or Current Tracker Module ports mapped to the wrong phase.
- Alternatively, power readings can be inverted within the Module Settings in the Savant Power & Light app

CT Wiring

1. Toggle power to electrical panel OFF
2. Pull to remove the terminal block from the module's rear panel
3. With a small flat-bladed screwdriver, turn the screws on the top of the connector counterclockwise until the silver crimps on the front of the connector open enough to slide the wire into the square space
4. Strip back the insulation of each CT wire to $\frac{1}{4}$ inch (6.5 mm)
5. Insert the stripped wire into the proper port. Do not allow more than $\frac{1}{8}$ inch (3.2 mm) of bare wire exposed. See the image to the right
6. Turn the screws clockwise until the silver crimps tighten around the wire. Tug on the wire a bit to verify the wire is installed securely
7. Continue until all wires are installed
8. Plug the terminal block into the appropriate port
9. Repeat steps 2-7 to install additional current transformers
10. Reapply power

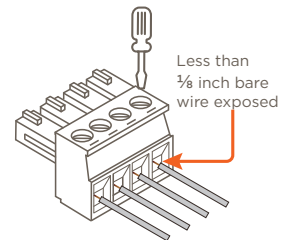
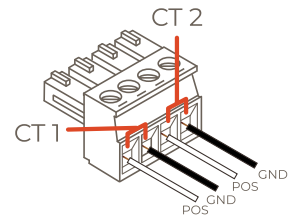

HELPFUL! The CT Module will report a negative current if the wires are reversed or the current transformer is installed backwards

System Overview

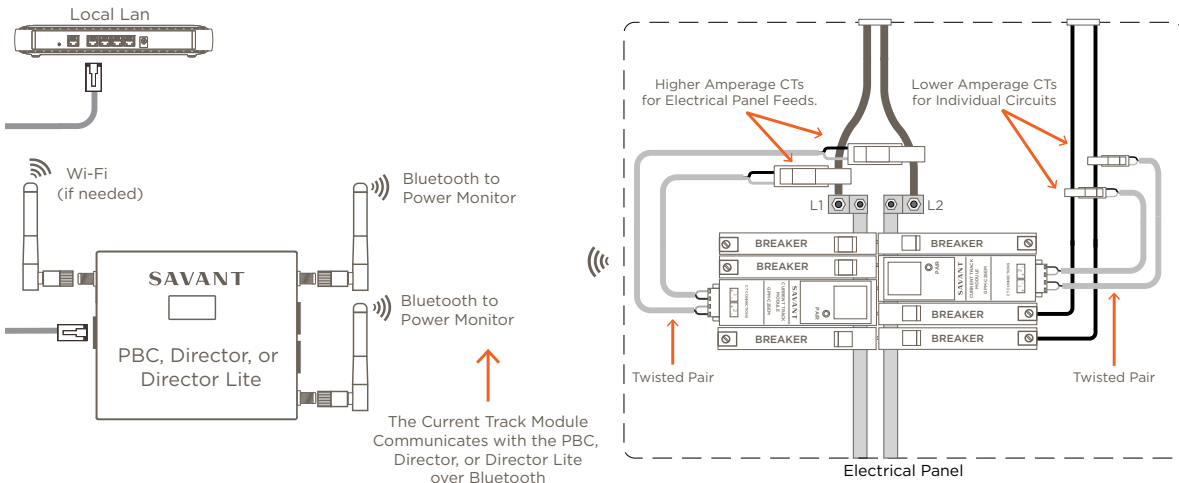

HELPFUL! A Class 2 Surge Protection device is recommended when installing Savant equipment in areas that experience frequent lightning or other transient voltage and current producing phenomena

LCD Screen Orientation

During power-up, the text and icons on the module LCD screen are oriented so they are right side up. If the text and icons are upside down, unplug and replug the Current Track Module to power cycle it.

CT Circuit Monitoring

The spaces in the electrical panel that the Current Track Module is plugged into and the wire being monitored must be on the same phase. Failure to do so will result in the module reporting a negative power output. See the diagram below:

CTs must monitor the legs of the system that match the legs of the spaces the module is installed into.

Example:

If space 1 of the Current Track Module is connected to L1, the Current Transformer wired to CT1 shown in CT Wiring must monitor L1. If space 2 is installed into L2, CT2 must monitor L2. The same applies if monitoring L3.

IMPORTANT! 3 phase CT circuit monitoring is supported using either an SEM-2015 connected to three phases or three Current Track Modules monitoring 3 phases independently of a Savant Host. 3 phase CT circuit monitoring using power modules paired to a Director, Director Lite, or Savant Host is not supported

HELPFUL TIP! In a single-phase electrical panel, phases L1 and L2 alternate spaces. In a three-phase panel, phases L1, L2, and L3 repeat every three spaces

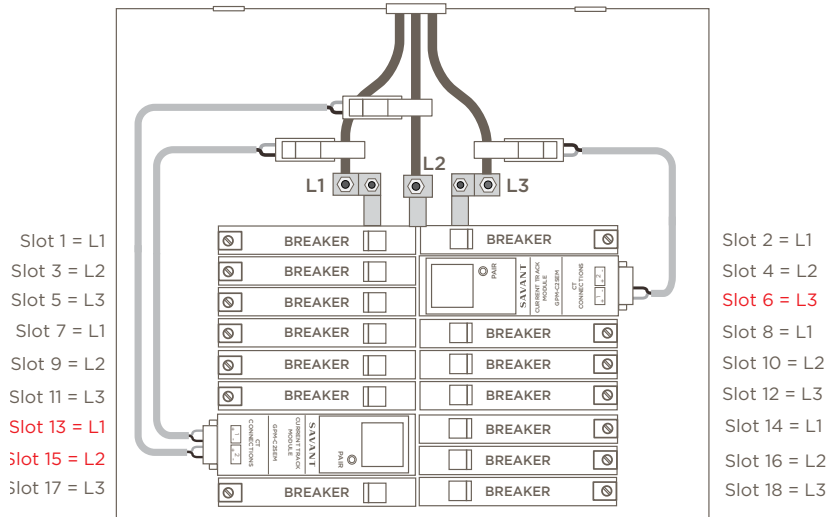

Additional Information

Once wiring and On Device setup has been completed, the module must be paired using the Savant Power & Light app. For more information, search for Savant Power & Light App (SP&L) - Initial Setup and Documentation Portal on the Savant Knowledgebase

On-Device Setup

Once the module is installed and powered, The LCD screen prompts the installer to configure the module location, CT size, and of the circuit being monitored by the Current Track Module through On-Device Setup. The progression of screens for this process is shown below. Screen options may differ depending on the selections made:

HELPFUL TIPS!:

- Press and release the PAIR button to scroll through the menu options.
- Press and hold the PAIR button to save the highlighted menu option and then navigate to the next screen.
- Scroll down and select | Exit | to leave setup and set up the device using the Savant Power & Light app.

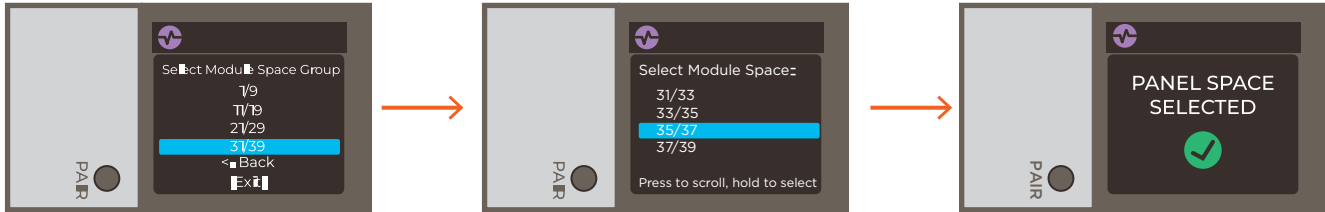

- Select a Module Space Group.
 - Select the spaces the Current Track Module is installed into.
- NOTE:** Space Group 1-8 is offered for panels with only one row of breaker spaces.
- NOTE:** Module orientation determines whether odd or even spaces are offered



- Select the size of the installed CT
 - Select the type of circuit to be monitored
- NOTE:** Additional selections for Production (Source) and Consumption (Room and Device) circuit types are required.

HELPFUL TIPS!:

- Press and release the PAIR button after completing On-Device Setup to confirm module status and information.
- To clear module labels from the module's display, complete On-Device Setup, press the pair button once more, then navigate to the Gateway screen, press and hold the PAIR button for 1 second, and follow the RESET instructions.

IMPORTANT!: After configuring the module using the On-Device setup, the module must be paired. Refer to the Savant Power & Light App (SP&L) - Initial Setup and Documentation Portal on the Savant Knowledgebase for pairing instructions.

LCD Screen Icon Descriptions

Icon	Description
	This icon indicates the device is a Current Track Module. Other modules such as the relay or dimmer display a different icon.
	The monitor is communicating with a controller such as a Panel Bridge Controller (PBC) or Director over Bluetooth. This icon appears when the module is discovered in the OLA server and communicating with a PBC or Director.
	The module is in Bluetooth Discovery Mode and ready to connect to any PBCs or Directors discovered by the OLA server. See the Bluetooth Discovery Mode section below for more information.

Reset Module

From any menu, press and hold the PAIR button for 5 seconds until the Reset screen; then release. A RESET IN screen opens and counts down from 5 seconds and resets. After the reset, any error conditions that exist, such as an overload, are cleared.

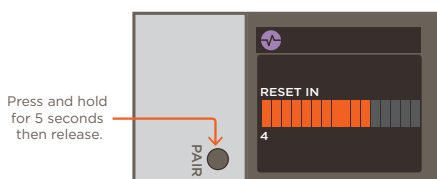

Bluetooth Discovery Mode

From any screen, press and hold the PAIR button for three seconds until the Bluetooth Discover icon appears, then release. In Discovery Mode, the module can now be connected to a PBC or Director. Discovery Mode is automatically disabled after 5 minutes and the module must be placed into Discovery mode again to be discovered.

